

# User Manual

## FoxESS EV Charger

Please read the product manual prior to installation to prevent improper operation.

# Table of Contents

1. Notes on This Manual .....	1
1.1 Scope of Validity .....	1
1.2 Target Group .....	1
1.3 Symbols Used .....	1
2. Safety .....	2
3. Packing List .....	3
4. Introduction .....	4
5. Technical Data .....	5
6. Charger installation .....	6
6.1 Product Handling .....	6
6.2 Out of the box inspection .....	6
6.3 Install .....	6
7. APP download .....	9
8. Operation .....	10
8.1 Charger Status Indicators .....	10
8.2 Charging mode and Operation .....	11
9. Maintenance .....	13
10. Decommissioning .....	14
10.1 Dismantling the charger .....	14
10.2 Packaging .....	14
10.3 Storage and Transportation .....	14

# 1. Notes on This Manual

## 1.1 Scope of Validity

This manual describes the assembly, installation, commissioning, maintenance and troubleshooting of the following model(s) of Fox products:

A011KP1-E1-R
A011KP1-E1-B
A011KP1-E1-S
A011KP1-E2-R
A011KP1-E2-B
A011KP1-E2-S
A011KS1-E1-R
A011KS1-E1-B
A011KS1-E1-S
A011KS1-E2-R
A011KS1-E2-B
A011KS1-E2-S





Note: Please keep this manual where it will be accessible at all times.







## 1.2 Target Group

This manual is for qualified electricians. The tasks described in this manual only can be performed by qualified electricians.

## 1.3 Symbols Used

The following types of safety instructions and general information appear in this document as described below:

	<b>Danger!</b> “Danger” indicates a hazardous situation which, if not avoided, will result in death or serious injury.
	<b>Warning!</b> “Warning” indicates a hazardous situation which, if not avoided, could result in death or serious injury.
	<b>Caution!</b> “Caution” indicates a hazardous situation which, if not avoided, could result in minor or moderate injury.
	<b>Note!</b> “Note” provides important tips and guidance.

Symbols	Explanation
	Symbol Explanation CE mark. The charger complies with the requirements of the applicable CE guidelines.
	Beware of hot surface. The charger can become hot during operation. Avoid contact during operation.
	Danger of high voltages. Danger to life due to high voltages in the charger!
	Danger. Risk of electric shock!
	Read the manual.
	Product should not be disposed as household waste.

## 2. Safety

FoxESS EV chargers are designed and tested in accordance with international safety requirements. However, certain safety precautions must be taken when installing and operating this. The installer must read and follow all instructions, cautions and warnings in this installation manual.

- All operations including transport, installation, start-up and maintenance, must be carried out by qualified, trained personnel.
- The electrical installation & maintenance of the charger shall be conducted by a licensed electrician and shall comply with local wiring rules and regulations.
- Before installation, check the unit to ensure it is free of any transport or handling. Unauthorized removal of necessary protections, improper use, incorrect installation and operation may lead to serious safety and shock hazards or equipment damage.
- Do not install the equipment in adverse environmental conditions such as in close proximity to flammable or explosive substances; in a corrosive or desert environment; where there is exposure to extreme high or low temperatures; or where humidity is high.
- Do not use the equipment when the safety devices do not work or are disabled.
- Use personal protective equipment, including gloves and eye protection during the installation.
- Inform the manufacturer about non-standard installation conditions.
- Do not use the equipment if any operating anomalies are found. Avoid temporary repairs.
- All repairs should be carried out using only approved spare parts, which must be installed in accordance with their intended use and by a licensed contractor or authorized FoxESS service partner.
- Liabilities arising from commercial components are delegated to their respective manufacturers.

### 3. Packing List



A



B

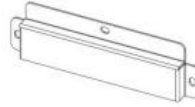

C

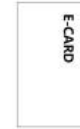

D



E



F



G



H

Object	Name	Qty
A	Charger	1
B	Mounting backplane	1
C	Mounting bracket	1
D	RFID card	2
E	Expansion tube	4
F	Expansion screw	4
G	Screw	5
H	Tubular terminal	5

## 4. Introduction

### Socket version

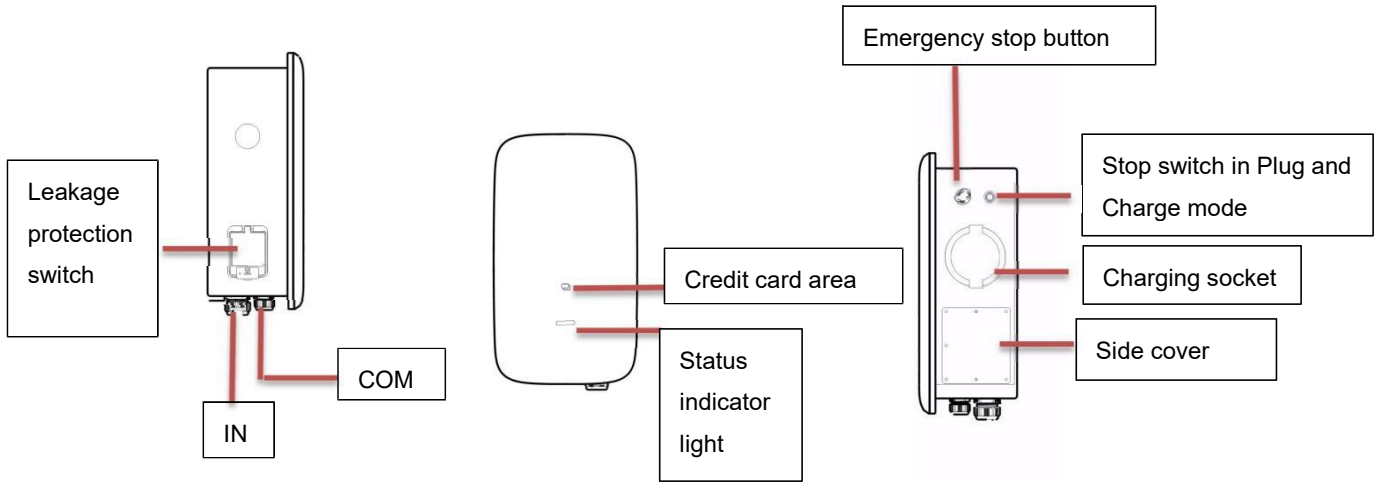

### Plug version

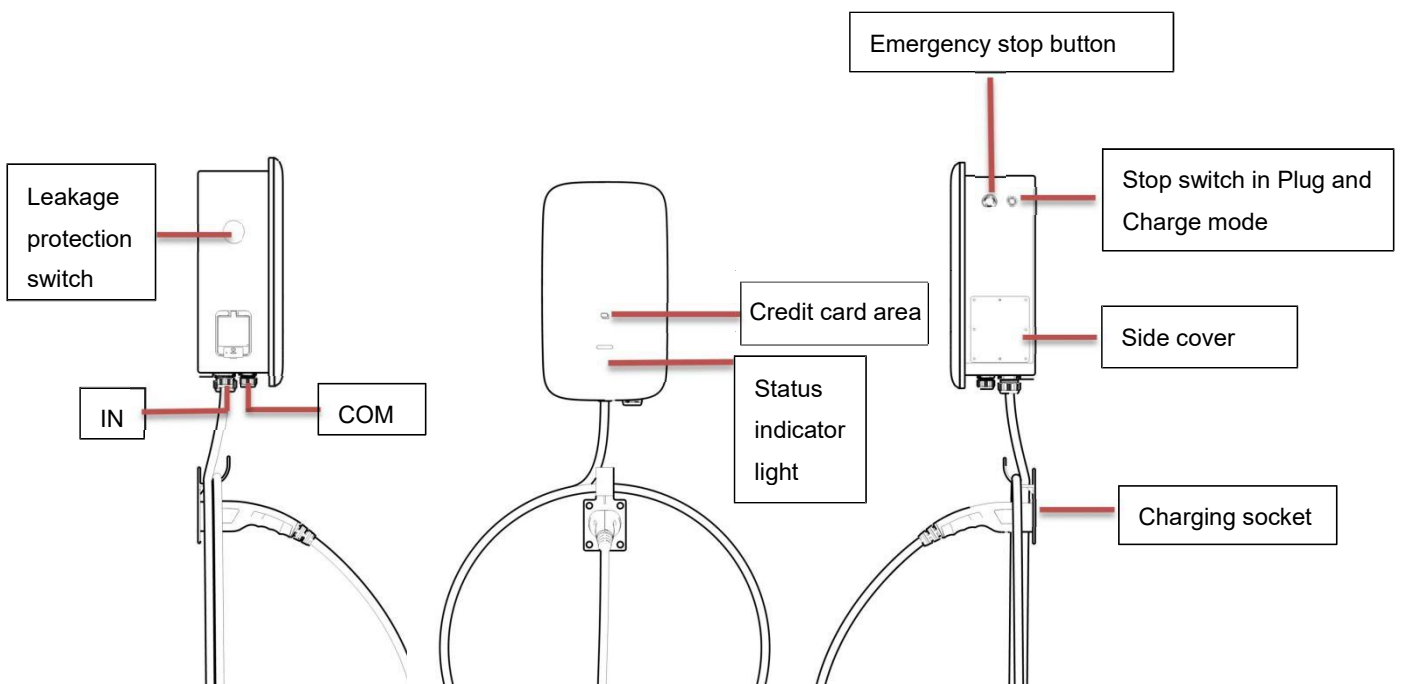

## 5. Technical Data

Model	A011KP1-E1 / A011KS1-E1
<b>General</b>	
Name	AC Charger
<b>Input</b>	
Input line	3P+N+PE
Rated voltage	400Vac, ±20%
Rated current	16A
Rated frequency	50/60Hz
<b>Output</b>	
Output voltage	400Vac, ±20%
Maximum output current	16A
Rated power	11kW
<b>Interaction method</b>	
Charging connection method	With cable/socket
Card reader	Mifare ISO/IEC 14443 A
Start-up mode	Plug and Charge/RFID Card/APP
<b>Communication method</b>	
Bluetooth	Yes
WiFi	Yes
<b>Using environment</b>	
Installation method	Wall mounting/column mounting
Working temperature	-25°C ~50°C
Working humidity	5%-95% no condensation
Altitude	≤2000m
<b>Size and weight</b>	
Size	480*275*180 mm
Weight	6.5kg(socket),8.8kg(plug)
<b>Safety</b>	
Waterproof rating	IP54
Anti-collision grade	IK08
Type A RCD	6mA DC
Protection function	Over-current protection, grounding protection, lightning protection, over-voltage protection, under-frequency protection, over temperature protection
Certification	CE/UKCA
Certification standard	EN/IEC 61851-1: 2019, EN/IEC 61851-21-2: 2018

## 6. Charger installation

### 6.1 Product Handling

To ensure safety, the following points should be paid attention to:

- All accessories are placed separately during transport or handling.
- Avoid violent shock and impact, and take it lightly.
- Avoid inversion.

### 6.2 Out of the box inspection

- Open the charging pile packaging, please check the random attachment according to the attachment list.
- Check the charging pile for damage in transport. If damage or missing parts are found, do not boot up and inform the carrier and dealer. Determine if this machine is the model that you want to purchase.

Note: Please keep the packing boxes and packaging materials for future handling.

### 6.3 Install

#### • Pre-installation preparation

The following tools are required for the installation:

Cross screwdriver, special plum screwdriver, stripping pliers, pressing pliers.

#### • Installation precautions

Please strictly follow the wiring requirements and correct access. Please confirm that all fasteners are locked to secure the charging pile.

#### • Installation placement environment and location

- The area where the charger must be placed must be well ventilated, far away from water, combustible gas and corrosive agent.
- Ensure that the ground or installation platform can withstand the weight of the charger.
- If the charger is disassembled and used at low temperature, there may be water droplets condensation phenomenon, be sure to wait for the charger inside and outside completely dry. After dryness can be installed and use, otherwise there is a danger of electric shock.
- Please place the charger near the mains input to disconnect the mains input switch and cut off the power supply in an emergency.

Note: The actual installation needs to comply with local installation requirements and local safety regulations.

Ensure that the wall or column is vertical or positive 15 ° before installation.

Vertical

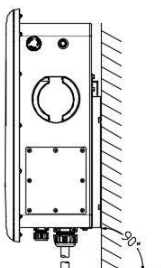

Front

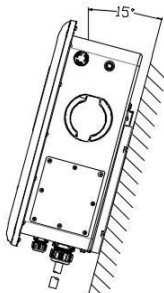

Tilt Back

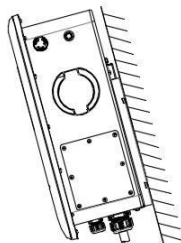

Tilt Flat

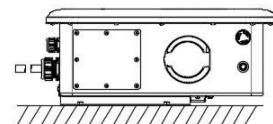



• **Wall-mounted installation method:**

1. Open the package and mark 4 holes in the wall ( $\varnothing 8 * 50\text{mm}$ ).
2. Fit into the expansion tube.
3. Attach the mounting backplane with screws to the mounting wall.
4. Attach the bracket to the charger.
5. Hang the charger into the mounting back plate and screw it.
6. Installation completed.

Note: Installation wall angle  $90^{\circ} \pm 15$ , thickness  $> 50\text{mm}$

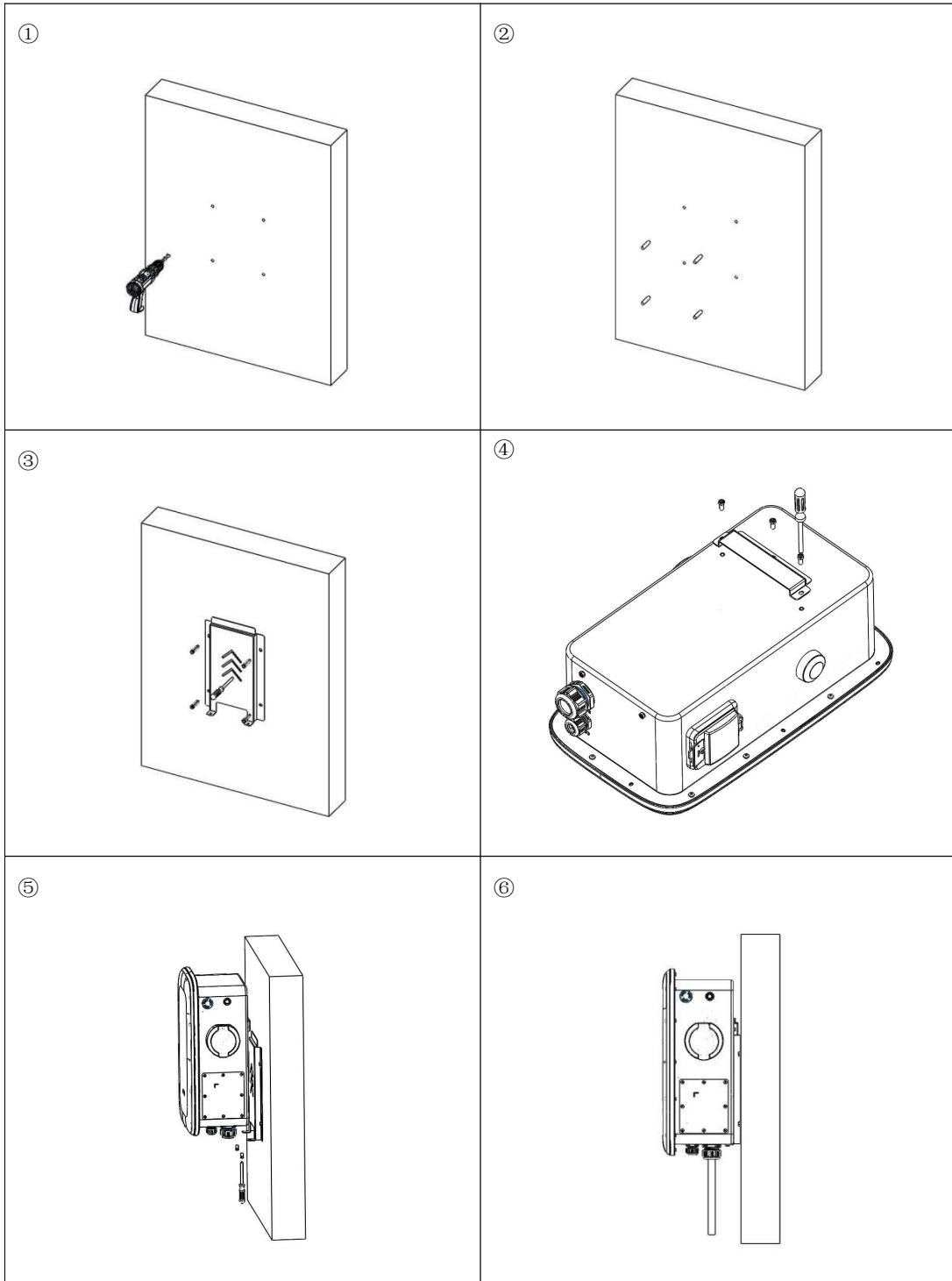

- **Floor type / Vertical installation method:**

1. Drill holes on the cement floor, four holes with diameter  $\phi$  12mm deep 60mm screws and one  $\phi$  60mm through duct hole.
2. Install and fix the anchor screws.
3. The input line runs through the column hole through the bottom of the column.
4. Install the backplane is fixed to the landing column with screws.
5. Attach the bracket to the charger.
6. Hang the charger into the mounting back plate and screw it well.
7. Installation completed.

Note: The angle of cement ground  $90+15^{\circ}\sim-0^{\circ}$

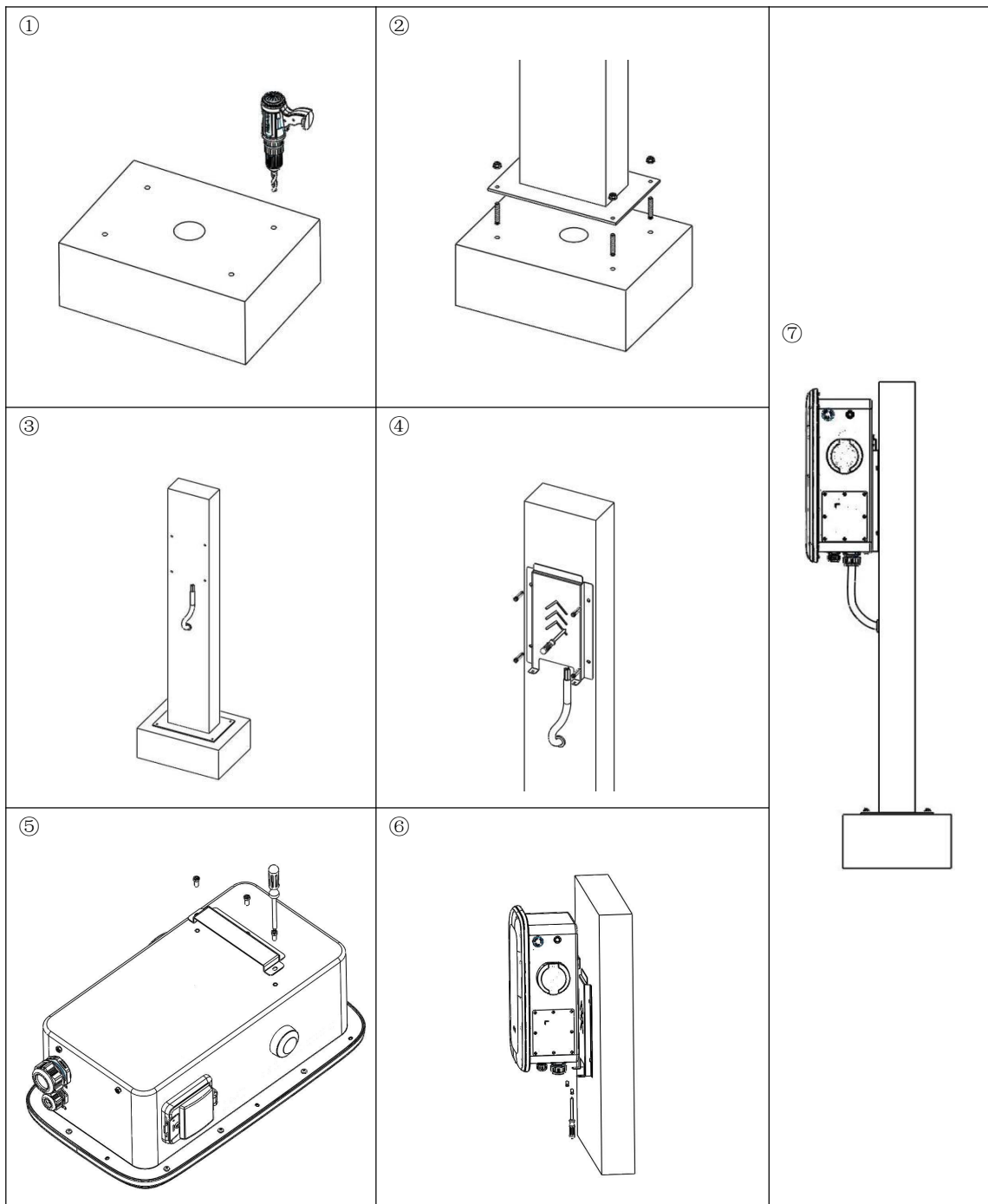

### Electrical Connection

**Step 1:** Peel five L1, L2, L3, N and PE copper 16mm with wire stripping pliers, and press L1, L2, L3, N, PE and tube terminals with terminal pliers.

**Step 2:** Loosen the screw nut and puncture the hole.

**Step 3:** Open the side cover, load the cable (13-18mm) and tighten the gram head.

**Step 4:** Unscrew the terminal screws. Link L.N.PE line lock the terminal screw, lock the side cover.

Note: choose 10~12 AWG five core wire

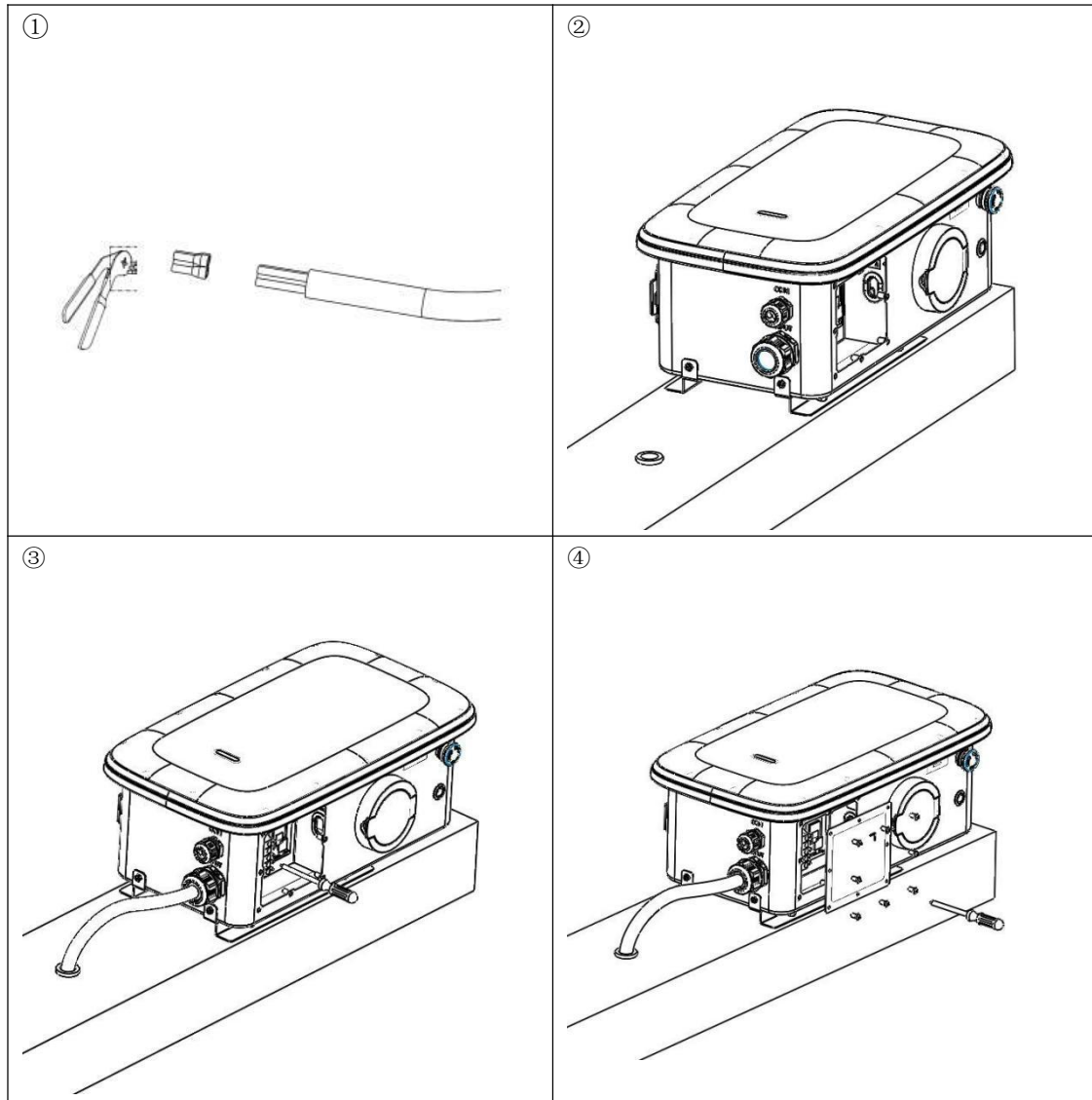

## 7. APP download

Users can scan the QR code (Android and IOS ) in the quick installation manual, or go to the App Store and Google Play to search for FoxSwitch.

## 8. Operation

### 8.1 Charger Status Indicators

LED Indicator description	Definition
Green Flashing	Device available
Blue Steady	EV connected, User not authorized
Blue Flashing	Authorized, Wait for charging
Blue marquee light	Charging
Blue Flashing	Charging suspension
Green Steady	Charging Finish, Wait for unplug
Yellow Steady	Charging Locking
Red Steady	Device Fault

## 8.2 Charging mode and Operation

Users can set three charging modes through the charging mode setting interface of the APP: controlled, locked, plug and charge.

### A. Plug and charge mode

Charging will start automatically after EV plugged in. If you want to stop the charging, just press the stop button on the side of the charger.

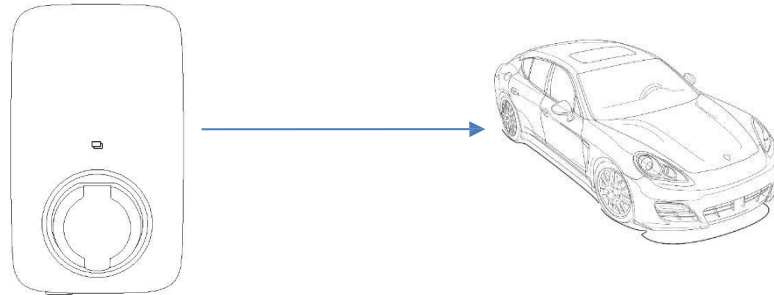

- **Start Charging:**
  1. Set the charger to the Plug and Charge mode
  2. Insert the charging plug into the EV
  3. Charging session started
- **Stop Charging:**

Press the stop button on the side of the charger.

### B. The controlled mode

Initiate or cease charging by using APP or by swiping RFID card on this mode. You can also use APP for Reservations.

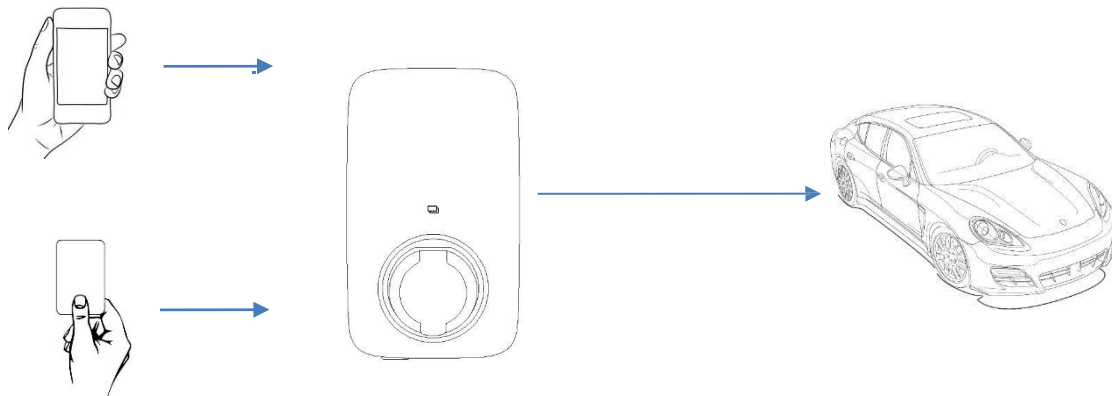

### The controlled mode with RFID card

- **Start Charging:**
  1. Set the charger to the Controlled mode
  2. Insert the charging plug into the EV
  3. Click to Start the Charge on the APP
  4. Waiting for authorizing
  5. Charging session started

- **Stop Charging:**
  1. Swipe card
  2. Charging session end

### **The controlled mode with APP**

- **Start Charging:**
  1. Set the charger to the Controlled mode
  2. Insert the charging plug into the EV
  3. Click to Start the Charge on the APP
  4. Waiting for authorizing
  5. Charging session started
- **Stop Charging:**
  1. Click to Stop the Charge on the APP
  2. Charging session end

### **C. The locked mode**

On this mode, the charger is locked and cannot be used.

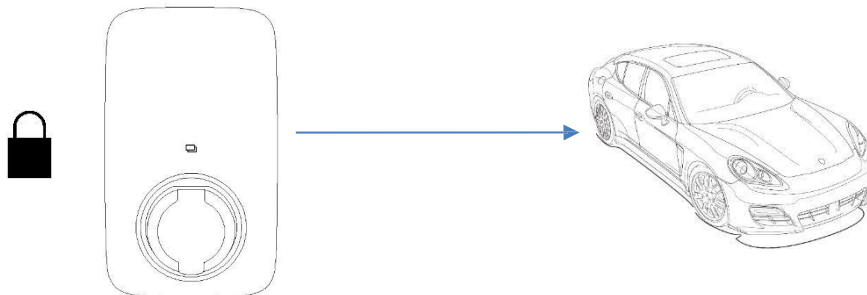

Note: Please refer to the app user manual for the specific operation of the app.

## 9. Maintenance

Troubleshoot by Alarm information on APP or LCD display.

If fault occurs, users can check the fault information on the APP or by blinks of the LED indicator light.

No.	Fault code on app	Solution
1	Electronic lock fault	Set the electronic lock status to the correct position. Or seek help from us.
2	Emergency stop fault	Reset the emergency stop button. Or seek help from us.
3	Abnormal CP voltage	seek help from us.
4	Abnormal AC output contactor	seek help from us.
5	Over current	Reduce output current. Or seek help from us.
6	Over voltage	Wait for the grid voltage to return to normal. Or seek help from us.
7	Undervoltage	Wait for the grid voltage to return to normal. Or seek help from us.
8	Electric leakage	seek help from us.
9	Reverse connection of lin N	Correctly connect P and N lines. Or seek help from us.
10	Abnormal frequency	Wait for the grid frequency to return to normal. Or seek help from us.
11	Over temperature of charging interface	Wait for the temperature of charging interface to return to normal. Or seek help from us.

# 10. Decommissioning

## 10.1 Dismantling the charger

- Disconnect the charger from AC Input and AC output.
- Disconnect communication and optional connection wirings. Remove the charger from the bracket.
- Remove the bracket if necessary.

## 10.2 Packaging

If possible, please pack the charger with the original packaging. If it is no longer available, you can also use an equivalent box that meets the following requirements.

- Suitable for loads more than 30 kg
- Contains a handle
- Can be fully closed

## 10.3 Storage and Transportation

Store the charger in dry place where ambient temperatures are always between  $-40^{\circ}\text{C}$  -  $+70^{\circ}\text{C}$ . Take care of the charger during the storage and transportation; keep less than 4 cartons in one stack. When the charger or other related components need to be disposed of, please ensure it is carried out according to local waste handling regulations. Please be sure to deliver any charger that needs to be disposed from sites that are appropriate for the disposal in accordance with local regulations.



The copyright of this manual belongs to FOXESS CO., LTD. Any corporation or individual should not plagiarize, partially or fully copy (including software, etc.), and no reproduction or distribution of it in any form or by any means is permitted. All rights reserved.  
Add: No.939, Jinhai Third Road, New Airport Industry Area, Longwan District, Wenzhou, Zhejiang, China  
Tel: 0510- 68092998  
WWW.FOX-ESS.COM.